





SECTION 11 / TOOLS & SUPPLIES

PRODUCT	PAGE
Rolling tools & replacement wheels.....	114
Fasteners & rivets	114
Saw blades, shears, riveter, metal lube, saw wax, sealant, one way tool, adapter, step drill, notching jig & spray paint	115
Cut off gauge	116
Glass framing components & glazing vinyls	116

SCREEN ROLLING & SPECIALTY TOOLS

All wood handles

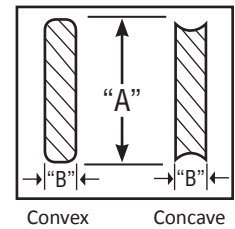

Product Line: K2500	Part No.	Wheel	Convex		Concave		Splines size
			A	B	A	B	
	PNSR-6000	Nylon	—	—	2"	3/32"	.115 - .145
	PNSR-6100	Nylon	—	—	2"	1/8"	.150 - .180
	PNSR-6200	Nylon	—	—	2"	5/32"	.185 - .215
	PNSR-6300	Nylon	—	—	2"	3/16"	.220 - .260
	PCR-7-20	Steel	2"	1/16"	2"	1/8"	.150 - .180
	PCR-6-22	Steel	2-1/2"	1/16"	2"	3/32"	.115 - .145
	PCR-7-22	Steel	2-1/2"	1/16"	2"	1/8"	.150 - .180
	PCR-8-22	Steel	2-1/2"	1/16"	2"	5/32"	.185 - .215
	PFR-4000 Flat roller	Steel	2" x 2" Flat				

Wheel measurements



MISCELLANEOUS TOOLS & SHOP SUPPLIES

SCREWS







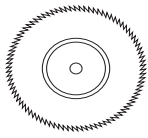
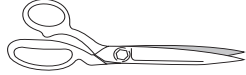

	Part No.	Product Line	Pack QTY	Description
Screen clip screws Phillips pan head-self tapping 	1052	K2606	100/Ctn.	10-24 x 5/8" (Plated)
	1053	K2606	100/Ctn.	10-24 x 3/4" (Plated)
	1054	K2606	100/Ctn.	10-24 x 1-1/4" (Plated)
	1055	K2606	100/Ctn.	10-24 x 1-5/8" (Plated)
Ball head screws Slotted ball head 	1068	K2604	100/Ctn.	8 x 1-1/4" (Ball latch screws)

BLIND RIVETS

	Part No.	Product Line	Description	Body length	Grip range
Aluminum rivets w/carbon steel mandrels 1/8" Dia. 	1082	K2608	AD 41 BS	.170	.020 - .064
	1083	K2608	AD 42 BS	.232	.065 - .125
	1084	K2608	AD 43 BS	.294	.126 - .187
	1085 (Steel)	K2608	AD 44 BS	.357	.188 - .250
	1086	K2608	AD 45 BS	.415	.251 - .312
	1087	K2608	AD 46 BS	.481	.313 - .375

**Specify adobe, almond, black, bronze, or white*

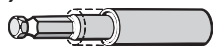
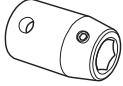
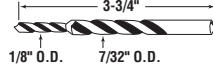
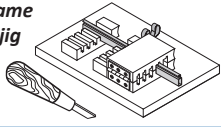
MISCELLANEOUS TOOLS & SHOP SUPPLIES

	Part No.	Product Line	Pack QTY	Description
Semi-high speed steel saw blades 	9593	K2500	1	(200 Teeth) 8" Diameter (Dia. x 1/16" x 5/8")
	9594	K2500	1	(200 Teeth) 10" Diameter (Dia. x 1/16" x 5/8")
	9596	K2500	1	(250 Teeth) 10" Diameter (Dia. x 1/16" x 5/8")
	<ul style="list-style-type: none"> • Carbon tool steel • For use on bench, radial arm and chop saws 		<ul style="list-style-type: none"> • 1/16" Thick 	<ul style="list-style-type: none"> • Type "A" teeth • 5/8" Arbor • Used for cutting screen and window frame
Deluxe screen shears 	9029	K2500	1	<ul style="list-style-type: none"> • 10" Heavy duty blades • Moly steel edge, resists abrasion • Offers easier cutting action • Use for fiberglass or aluminum screen
Heavy duty shears 	9030	K2500	1	<ul style="list-style-type: none"> • 11-1/4" Heavy duty blades • Stainless steel with adjustable screw • Ergonomic grip • Use for left or right handed cutting
Hand "pop" riveter 	9653	K2500	1	Sturdy, efficient hand riveter suitable for low production, prototype or field fastening applications. Comes equipped with interchangeable nosepiece for larger diameter rivets.
Precision metal lube 	1007	K2550	12/Case	13 oz. Aerosol can
Saw wax 	1014	K2550	1/Pkg. 12/Case	<ul style="list-style-type: none"> • (16 oz.) 1-1/2 # Tubes • Lubricant for chop saw blades • Allows for smoother saw cut and eliminates burring • Add life to saw blades
High performance sealant (clear) 	2858	F3807	1	100% Silicone (Acetoxy, permanent flexibility, excellent weatherability)
One way tool 	8900	G8100	1	5/16" One way driving tool
Adapter 	8901	G8100	1	5/16" Drive tool adapter, used for 1/2" square drive
Step drill 	9017	K2500	1	Step drill 7/32" x 1/8" — Used to easily drill correct hole sizes for installation of plunger latches
Screen frame notching jig 	9024	K2550	1/Box	<ul style="list-style-type: none"> • Allows frame to be securely held while being notched • Notched frame allows application of slide locks, tension springs and knife latches • Notching tool included
Precision spray paint (12 oz. Aerosol Can) 	8720 8721 8722 8723 8727 8757	G8705	12/Case	Semi gloss black Bronze Semi-gloss white Almond Adobe Weathered brown

MISCELLANEOUS TOOLS & SHOP SUPPLIES

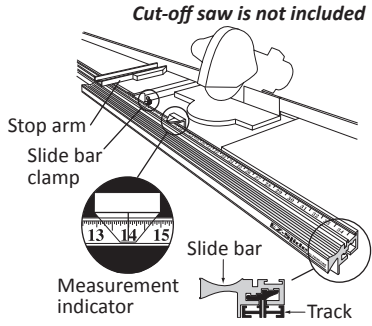

E-Z SLIDE CUT-OFF GAUGE

1. A unique measuring device for cut-off saws requiring fast and accurate lineal measuring.
2. Ideal for use with Precision's full size chop saw table kit (Part No. P 8061).
3. Accurately measures screen frame lengths from 6" to 108".
4. All measurements are read directly in front of chop saw, for maximum operator efficiency.

Recommended Gauge Selection

If operator is **LEFT HANDED**, order a **right** hand stop gauge.
If operator is **RIGHT HANDED**, order a **left** hand stop gauge.

Part No.	Product Line	Pack QTY	Description
9704	K2550	1	Right hand stop replacement tape for P 7925

GLASS FRAMING COMPONENTS & GLAZING VINYL

	Part No.	Product Line	Description	Finish	Length	Pcs/Pack
Glazing vinyl 	1104BK	K1510	SS Glazing vinyl	Black	750'	1
	1105BK	K1510	DS Glazing vinyl	Black	1000'	1
3/4" Muntin bar 	1111WH	A1010	3/4" Muntin bar .025	White	12'8"	125
Roll form grid bar 	1118WH	A1010	3/4" Roll form grid bar	White	12'0"	300
	1118BZ	A1010	3/4" Roll form grid bar	Bronze	12'0"	300
Roll form glazing bead 	1127ML	A1010	Roll form glazing bead	Mill	12'0"	75
	1127GR	A1010	Roll form glazing bead	Gray	12'0"	75
	1127WH	A1010	Roll form glazing bead	White	12'0"	75
	1127BZ	A1010	Roll form glazing bead	Bronze	12'0"	75

*5 Box minimum